

TECHNICAL BULLETIN: M/L-705

Installation Instructions and Requirements for MXBP, MXBN, MXRM, and MXBL Isolation Elements™



MXBP



MXBN



MXRM



MXBL

Vibro/Dynamics Technologically Advanced Machinery Mounting Systems are an investment in productivity and efficiency. To realize the full potential of your investment, familiarize yourself with these instruction requirements to insure a successful installation.

© Copyright 2007-2019 Vibro/Dynamics LLC
All Rights Reserve

TECHNICAL BULLETIN: M/L-705

FOUNDATION REQUIREMENTS

1. Foundation piers must be poured so that the press is at its desired elevation. Isolation element height must be taken into account. Refer to the isolation element's specification sheet for dimensions.
2. The top of the foundation piers should have a brushed concrete finish. There should not be any holes, cracks, peaks or valleys under the isolation element. Pier elevation should be within 1/8" (3 mm). See Figure 1.
3. The foundation pier area must be large enough so that the isolation element does not overhang. The concrete surface directly under the isolation element must be clean and meet the flatness and slope tolerances shown in Table One in the Appendix.
4. Epoxy Grout Caps or Grout (Sole) plates are recommended if the Flatness and Slope tolerances cannot be met.

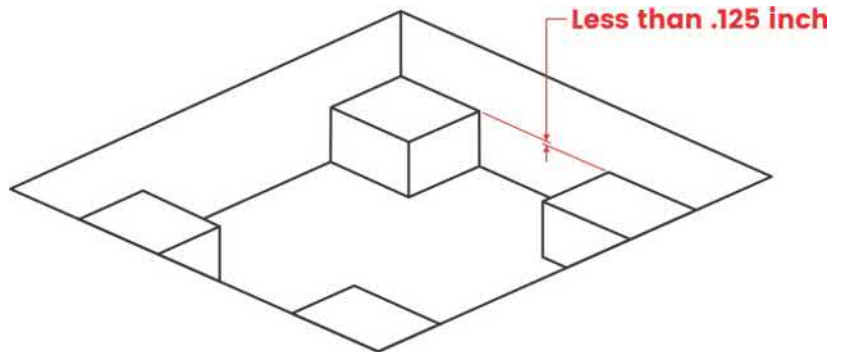
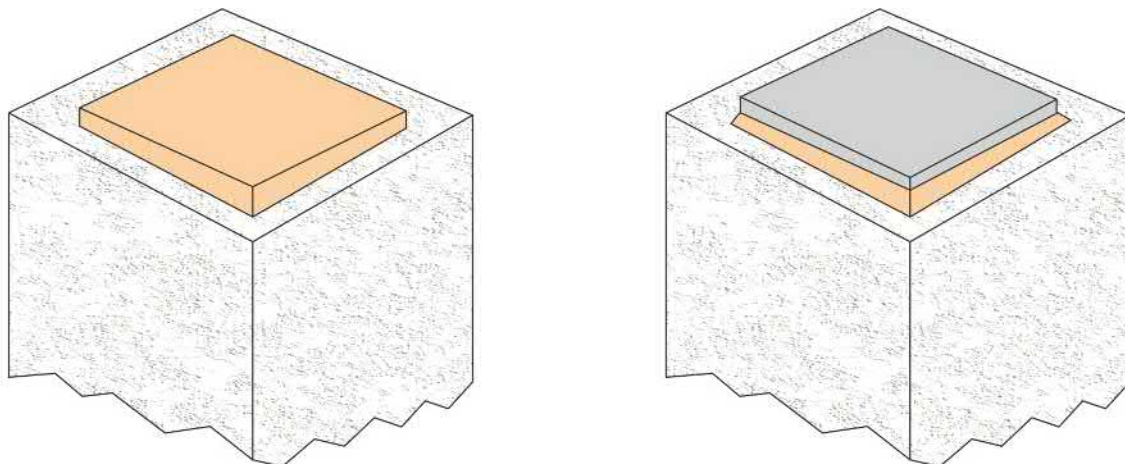

Figure 1



Epoxy Grout Caps and Grout Plates to correct sloped foundation piers.

Figure 2

5. The purpose of the caps or plates is to ensure that all the modular resilient members in the isolation elements are evenly loaded. If epoxy grout is used, it should be thin enough to "self-level" when poured into a form.

6. If grout plates are used, they must be flat, (a 125 Blanchard ground or shot-peened finish is recommended), anchored and grouted into place. It is *critical* that all grout access holes are filled with grout until the grout is even with the top of the plate as shown in Figure 3. Any hole or gap under the element will cause uneven loading and the element will not function as designed.

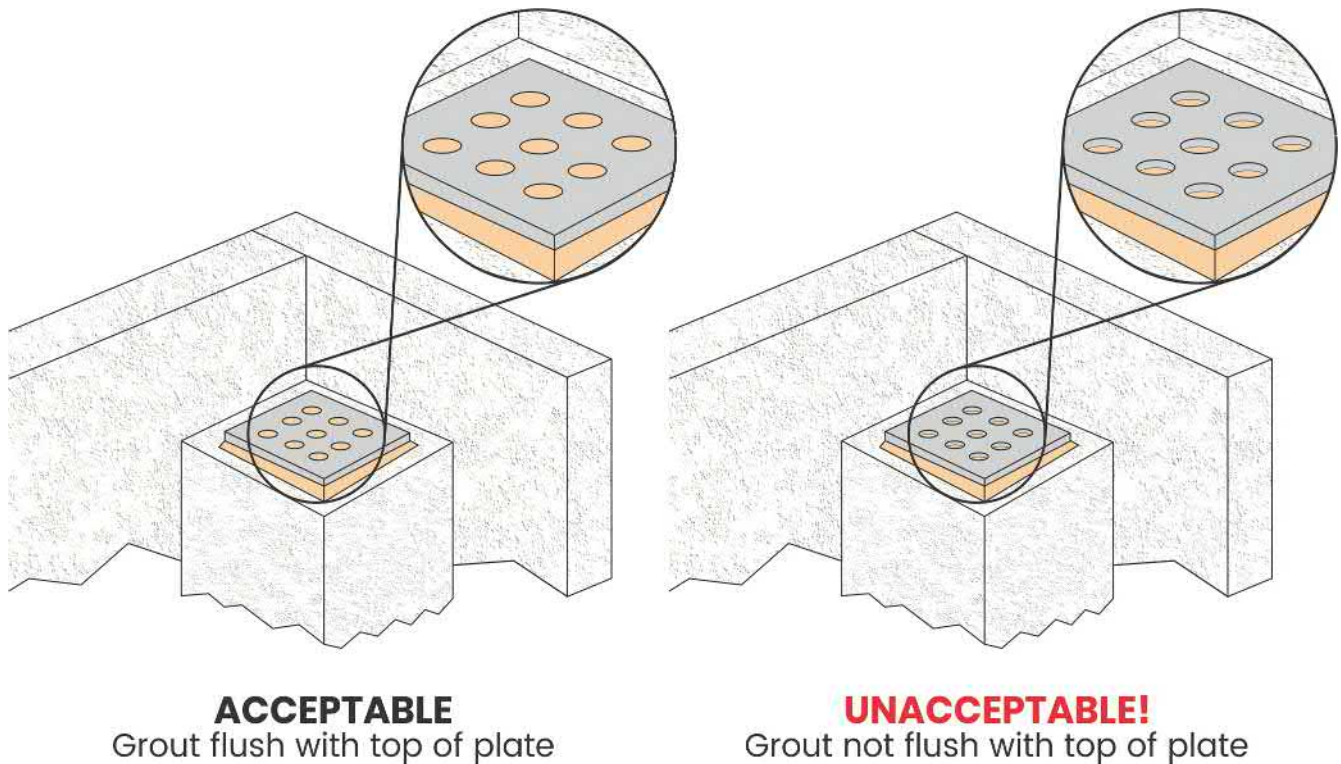

Figure 3

7. There should not be any solid connections between the machine and the foundation or building structure. Flexible connections are recommended for plumbing and electrical conduit. Floor plates, walkways, railings, etc. should not be attached to both the machine and the floor, foundation or building. Hard connections will “short-circuit” isolation effectiveness.

TECHNICAL BULLETIN: M/L-705

8. Clearance should be provided in either the X or Y direction to allow for the installation or removal of the isolation elements. See Figure 4. Dimensions X and Y should be slightly greater than the corresponding isolation element dimension. *For example*, dimension X should be greater than the length of the isolation element or dimension Y should be greater than the width of the isolation element. Refer to the Isolation element Specification Sheet for dimensions.

Note: It may be possible to remove the isolation element by moving it toward the center of the press and then into a pit but providing clearance around the isolation element is the preferred method.

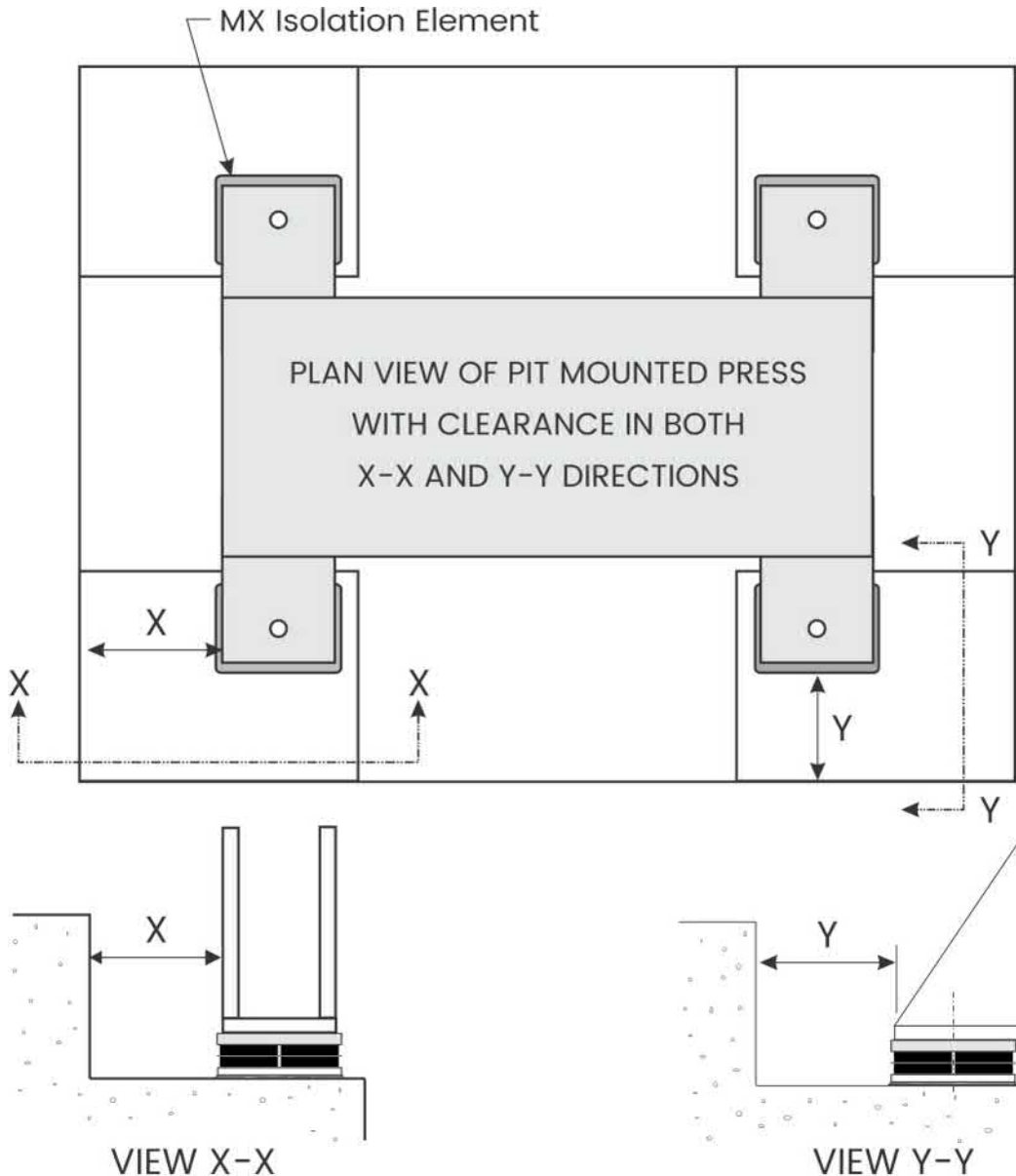

Figure 4

9. If rolling bolster plates or die carts are going to be used, they should be installed in accordance with Figure 5. Since the isolation elements are resilient, they will deflect during loading and unloading of the die. The first method shown is preferred since rolling bolster beam floats with a changing press elevation, negating any alignment problems.

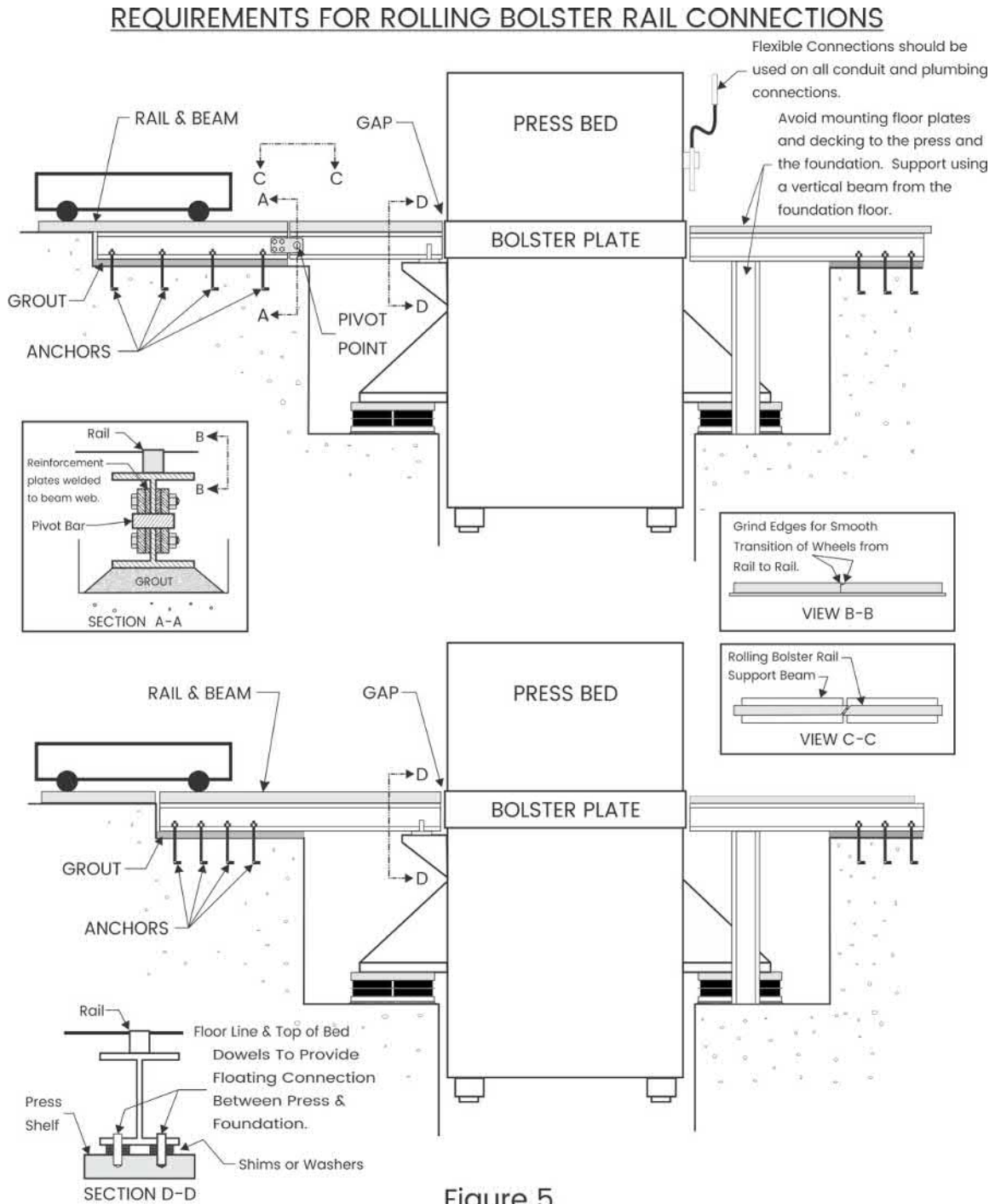

Figure 5

INSTALLATION INSTRUCTIONS

MACHINE INSPECTION

1. Clean and inspect the machine feet and legs. Repair any cracks or damage. The bottom of the machine feet/base must be clean and flat where it contacts the top of the isolation element.
2. Clean debris from the mounting holes for installations using optional attachment bolts.

ISOLATION ELEMENT INSTALLATION

3. Position each isolation element under the machine foot or base.
4. For isolation elements equipped with attachment bolts, position the isolation element under the machine foot so the tapped hole or welded nut in the isolation element is concentric with the machine's mounting hole as per Figure 6.
5. Lower the machine onto the isolation element.
Note: For MXRM and MXBL installations, the machine foot must cover the entire area of the isolation element. These isolators will not be loaded correctly if the isolator protrudes out from under the foot. A MXBP or MXBN must be used for these situations.
6. For isolation elements equipped with attachment bolts, insert the bolt through the hole in the machine foot and thread into the tapped hole in the top of the isolation element. Make sure that the bolt is not turned in too far, causing damage to the isolation element.

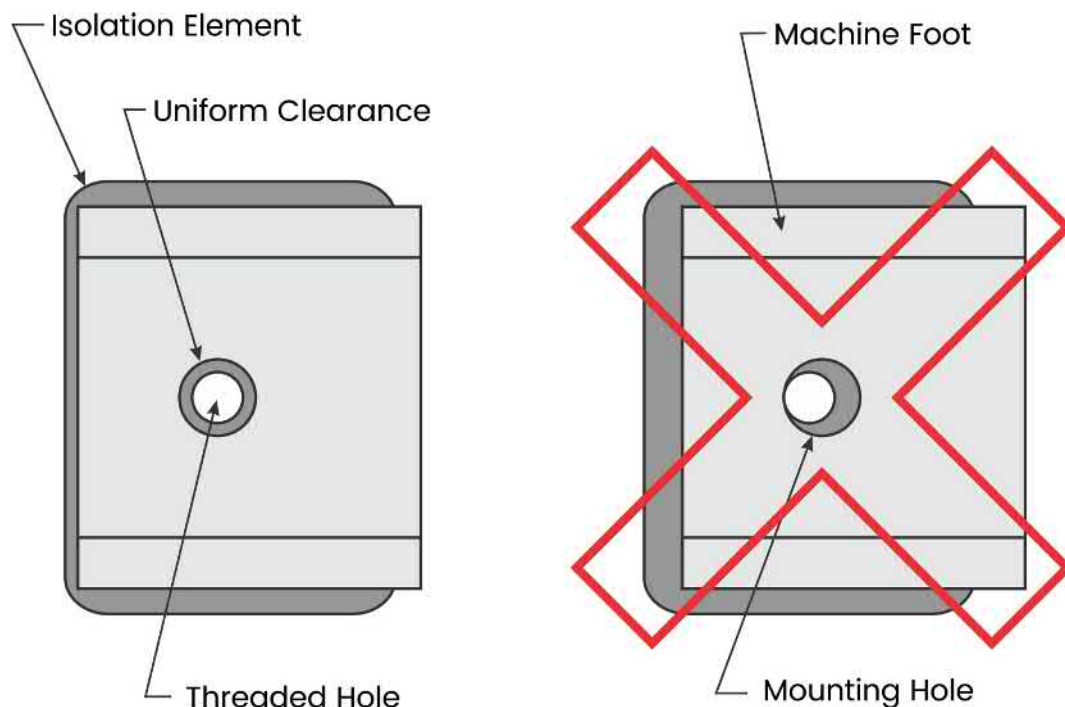

Figure 6

TECHNICAL BULLETIN: M/L-705

LEVELING

A Shim Pack is provided for approximately $\frac{1}{4}$ " (6mm) of leveling adjustment. The shims are placed between the machine foot and the isolator. See Figures 7 and 8. The steel shims are provided with double stick tape on one side. Remove the backing from the tape and place the shim into position. For isolators without attachment bolts avoid steel-on-steel contact.

- **MXBN, MXBL, and MXRM** isolation elements require external lifting devices, such as an overhead crane or hydraulic cylinders placed outside of the isolation elements, to insert shims between the top of the isolation element and the machine foot. See Figure 7.
 - **MXBP** isolation elements can use external lifting devices or hydraulic cylinders can be placed within the element to raise the machine foot off the element to insert shims. See Figure 8. **Note:** The hydraulic cylinders should be connected together via a manifold to equalize the hydraulic pressure. This ensures uniform lifting pressure and loading of the element.
 - For installations using optional attachment bolts, the shim pack is cut in two, allowing for placement of equal stacks of shims on both sides of the attachment bolt.
7. Refer to the machine manual for the machine's leveling locations and tolerances.
 8. Using a precision machinists' level, or laser, determine the machine's low side in the front-to-back direction.
 9. Apply an equal amount of shims to all isolation elements on the low side until the machine is level in that direction.
 10. Repeat procedure in the left-to-right direction.
 11. Repeat the above Steps until the machine is level.
 12. Tighten Attachment Bolts and Nuts if so supplied.

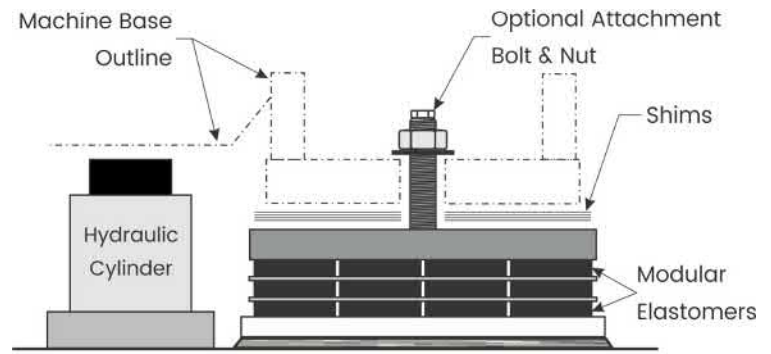

Figure 7

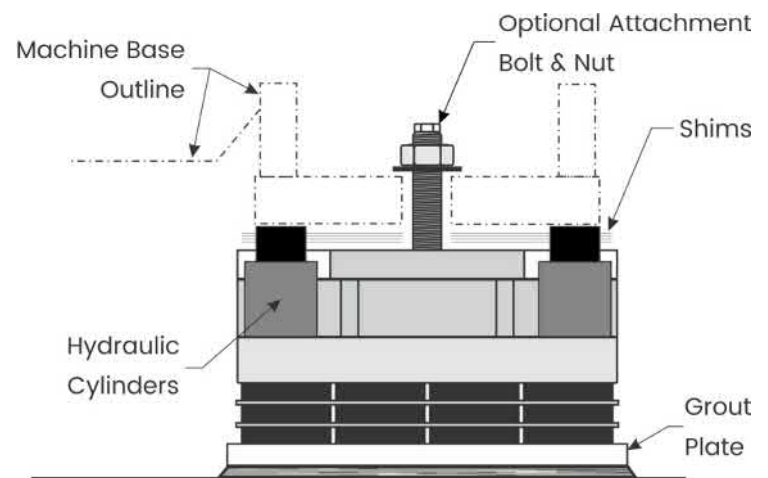

Figure 8

Please call us at 1-800-842-7668 for assistance or questions regarding your installation.

TECHNICAL BULLETIN: M/L-705

APPENDIX Table One (*MXB_ designates MXBP, MXBN and MXBL models)

MXB_° Models	Flatness Tolerance *		Slope Tolerance		MXB_° Models	Flatness Tolerance *		Slope Tolerance	
	Inches *	metric *	Inches/ foot	mm/ meter		Inches *	metric *	Inches/ foot	mm/ meter
24MXB_0801	0.07	1.7	0.04	3.7	35MXB_2851	0.07	1.7	0.03	2.5
24MXB_0802	0.07	1.7	0.09	7.4	35MXB_2852	0.07	1.7	0.06	5.0
24MXB_0803	0.07	1.7	0.13	11.1	35MXB_2853	0.07	1.7	0.09	7.5
24MXB_0804	0.07	1.7	0.18	14.8	35MXB_2854	0.07	1.7	0.12	10.0
24MXB_0951	0.07	1.7	0.04	3.7	35MXB_3721	0.05	1.3	0.02	1.9
24MXB_0952	0.07	1.7	0.09	7.4	35MXB_3722	0.05	1.3	0.05	3.8
24MXB_0953	0.07	1.7	0.13	11.1	35MXB_3723	0.05	1.3	0.07	5.8
24MXB_0954	0.07	1.7	0.18	14.8	35MXB_3724	0.05	1.3	0.09	7.7
24MXB_1241	0.05	1.3	0.03	2.8	36MXB_4321	0.04	1.0	0.02	1.5
24MXB_1242	0.05	1.3	0.07	5.7	36MXB_4322	0.04	1.0	0.04	3.1
24MXB_1243	0.05	1.3	0.10	8.5	36MXB_4323	0.04	1.0	0.06	4.6
24MXB_1244	0.05	1.3	0.14	11.4	36MXB_4324	0.04	1.0	0.07	6.2
25MXB_1441	0.04	1.0	0.03	2.3	36MXB_4801	0.03	0.6	0.01	1.0
25MXB_1442	0.04	1.0	0.05	4.5	36MXB_4802	0.03	0.6	0.02	1.9
25MXB_1443	0.04	1.0	0.08	6.8	36MXB_4803	0.03	0.6	0.03	2.9
25MXB_1444	0.04	1.0	0.11	9.1	36MXB_4804	0.03	0.6	0.05	3.9
25MXB_1601	0.03	0.6	0.02	1.4	48MXB_4281	0.07	1.7	0.02	1.8
25MXB_1602	0.03	0.6	0.03	2.9	48MXB_4282	0.07	1.7	0.04	3.5
25MXB_1603	0.03	0.6	0.05	4.3	48MXB_4283	0.07	1.7	0.06	5.3
25MXB_1604	0.03	0.6	0.07	5.7	48MXB_4284	0.07	1.7	0.08	7.0
30MXB_1201	0.07	1.7	0.03	2.5	48MXB_5581	0.05	1.3	0.02	1.3
30MXB_1202	0.07	1.7	0.06	5.0	48MXB_5582	0.05	1.3	0.03	2.7
30MXB_1203	0.07	1.7	0.09	7.5	48MXB_5583	0.05	1.3	0.05	4.0
30MXB_1204	0.07	1.7	0.12	10.0	48MXB_5584	0.05	1.3	0.06	5.4
30MXB_1431	0.07	1.7	0.03	2.5	50MXB_6481	0.04	1.0	0.01	1.1
30MXB_1432	0.07	1.7	0.06	5.0	50MXB_6482	0.04	1.0	0.03	2.2
30MXB_1433	0.07	1.7	0.09	7.5	50MXB_6483	0.04	1.0	0.04	3.2
30MXB_1434	0.07	1.7	0.12	10.0	50MXB_6484	0.04	1.0	0.05	4.3
30MXB_1861	0.05	1.3	0.02	1.9	50MXB_7201	0.03	0.6	0.01	0.7
30MXB_1862	0.05	1.3	0.05	3.8	50MXB_7202	0.03	0.6	0.02	1.4
30MXB_1863	0.05	1.3	0.07	5.8	50MXB_7203	0.03	0.6	0.02	2.0
30MXB_1864	0.05	1.3	0.09	7.7	50MXB_7204	0.03	0.6	0.03	2.7
31MXBN_2161	0.04	1.0	0.02	1.5	58MXB_5701	0.07	1.7	0.02	1.3
31MXBN_2162	0.04	1.0	0.04	3.1	58MXB_5702	0.07	1.7	0.03	2.6
31MXBN_2163	0.04	1.0	0.06	4.6	58MXB_5703	0.07	1.7	0.05	3.9
31MXBN_2164	0.04	1.0	0.07	6.2	58MXB_5704	0.07	1.7	0.06	5.2
33MXBN_1601	0.07	1.7	0.03	2.6	58MXB_7441	0.05	1.3	0.01	1.0
33MXBN_1602	0.07	1.7	0.06	5.3	58MXB_7442	0.05	1.3	0.02	2.0
33MXBN_1603	0.07	1.7	0.09	7.9	58MXB_7443	0.05	1.3	0.04	3.0
33MXBN_1604	0.07	1.7	0.13	10.5	58MXB_7444	0.05	1.3	0.05	4.0
33MXBN_1901	0.07	1.7	0.03	2.6	60MXB_8641	0.04	1.0	0.01	0.8
33MXBN_1902	0.07	1.7	0.06	5.3	60MXB_8642	0.04	1.0	0.02	1.6
33MXBN_1903	0.07	1.7	0.09	7.9	60MXB_8643	0.04	1.0	0.03	2.4
33MXBN_1904	0.07	1.7	0.13	10.5	60MXB_8644	0.04	1.0	0.04	3.2
33MXBN_2481	0.05	1.3	0.02	2.0	68MXB_7601	0.07	1.7	0.02	1.3
33MXBN_2482	0.05	1.3	0.05	4.0	68MXB_7602	0.07	1.7	0.03	2.6
33MXBN_2483	0.05	1.3	0.07	6.0	68MXB_7603	0.07	1.7	0.05	3.9
33MXBN_2484	0.05	1.3	0.10	8.1	68MXB_7604	0.07	1.7	0.06	5.2
34MXB_2881	0.04	1.0	0.02	1.6	68MXB_9921	0.05	1.3	0.01	1.0
34MXB_2882	0.04	1.0	0.04	3.2	68MXB_9922	0.05	1.3	0.02	2.0
34MXB_2883	0.04	1.0	0.06	4.8	68MXB_9923	0.05	1.3	0.04	3.0
34MXB_2884	0.04	1.0	0.08	6.5	68MXB_9924	0.05	1.3	0.05	4.0
34MXB_3201	0.03	0.6	0.01	1.0	68MXB_11521	0.04	1.0	0.01	0.8
34MXB_3202	0.03	0.6	0.02	2.0	68MXB_11522	0.04	1.0	0.02	1.6
34MXB_3203	0.03	0.6	0.04	3.0	68MXB_11523	0.04	1.0	0.03	2.4
34MXB_3204	0.03	0.6	0.05	4.1	68MXB_11524	0.04	1.0	0.04	3.2